

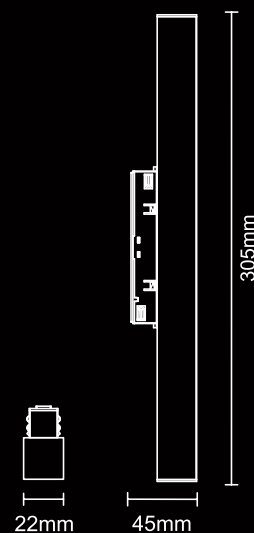

THOR 03

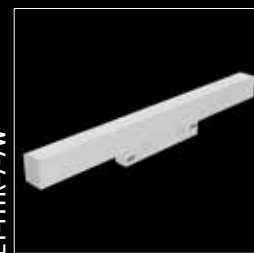

Color	Black / White
Material	Aluminium
Power	7W
Lumen	420lm
Beam Angle	120°
CRI	≥90
UGR	<19 - prismatic
CCT	3000k / 4000k
IP rate	IP20
Driver	On-Off / DALI / 0-10V / zigbee
Sizes	L305*W22*H45mm
SDCM	≤3
Mounting type	Magnetic track
Lamp type	LED SMD
Voltage	DC48V
Output LED driver	200mA 36V
Lifetime	50.000h
Blue light	RG0



LY-MTR-7-7W

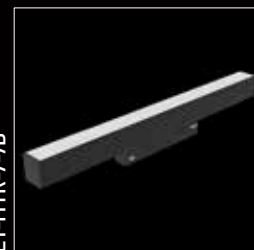

LY-MTR-7-7B



110° 3000K

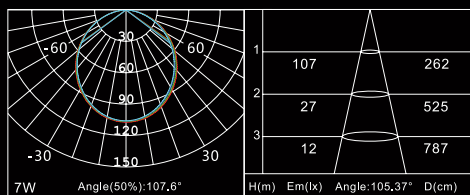

LYSET

everything is about light

INSTRUCTIONS MANUAL

Thank you for selecting our product. To ensure safe and proper use, please carefully read the installation instructions before proceeding.

For installation, repair, or testing, we strongly recommend engaging a licensed professional electrician. Adhering to the provided guidelines is essential to prevent risks such as electrical shock, fire hazards, or accidental damage.

Important safety considerations:

- Do not install the lamp on ceilings that are weak or unstable.
- Avoid installation in areas with high heat, such as above stoves, near gas vents, exhaust outlets, or in spaces prone to moisture.
- This lamp is not compatible with dimming systems or motion sensors; do not connect it to such systems.

Your safety is our priority. Please follow the instructions diligently for optimal performance and peace of mind.

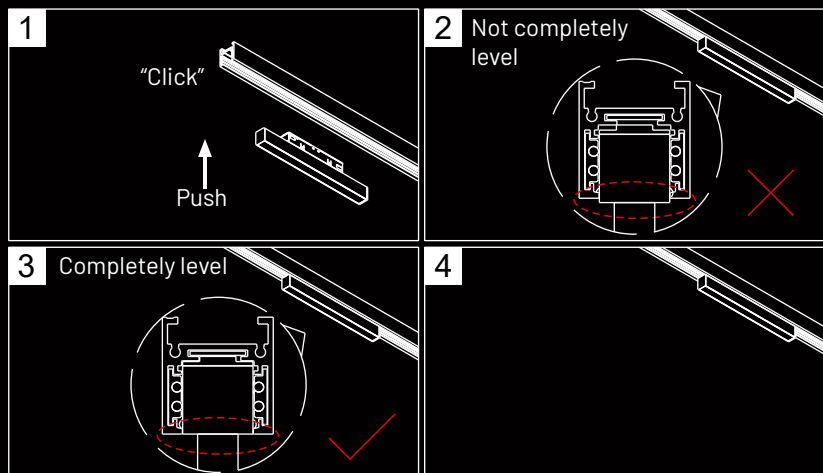
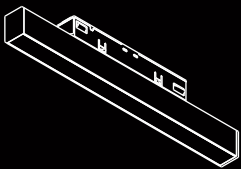

Note:
The positive and negative (+, -) signal terminal of 0-10V dimming luminous must be installed corresponding to the input terminal.

The positive and negative (+, -) signal terminal of DALI dimming luminous, the signal terminal does not need to be installed corresponding to the input terminal.

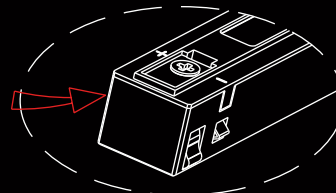

DECLARATION OF CONFORMITY

We, A.B. PROPERTY SERVICES SRL, hereby declare, that the item(s)

BRAND: Lyset

Model No.: LY-MTR-7-7B / LY-MTR-7-7W

to which this declaration related is in conformity with the following
European Council Standard(s):

Low Voltage Directive 2014/35/EU as tested against following
harmonized standards:

EN IEC 60598-1:2021/A11:2022

EN IEC 60598-2-1:2021

EN 62493:2015

Electromagnetic Compatiltiy Directive 2014/30/EU as tested against following
harmonized standards:

EN IEC 55015:2019

EN IEC 55015:2019/A11:2020

EN 61547:2009

IEC 61000

RoHS Directive 2011/65/EU as tested against following harmonized standard:

EN 50581:2012

EcoDesign requirements for energy related products Directive (ErP), 2009/125/EC and
applicable Implementing Measures

2019/2020/EU

On behalf of A.B. PROPERTY SERVICES SRL

Alexandru Boangher

Managing Director



LYSET

everything is about light